

Appendix

A

Solids Challenge 1

This drawing is present to challenge anyone with the time and the energy to duplicate the standards of the solids problem. The drawing requires the same skill set as learned in Unit 1, so you should be able to achieve a similar CAD drawing time and accuracy score.

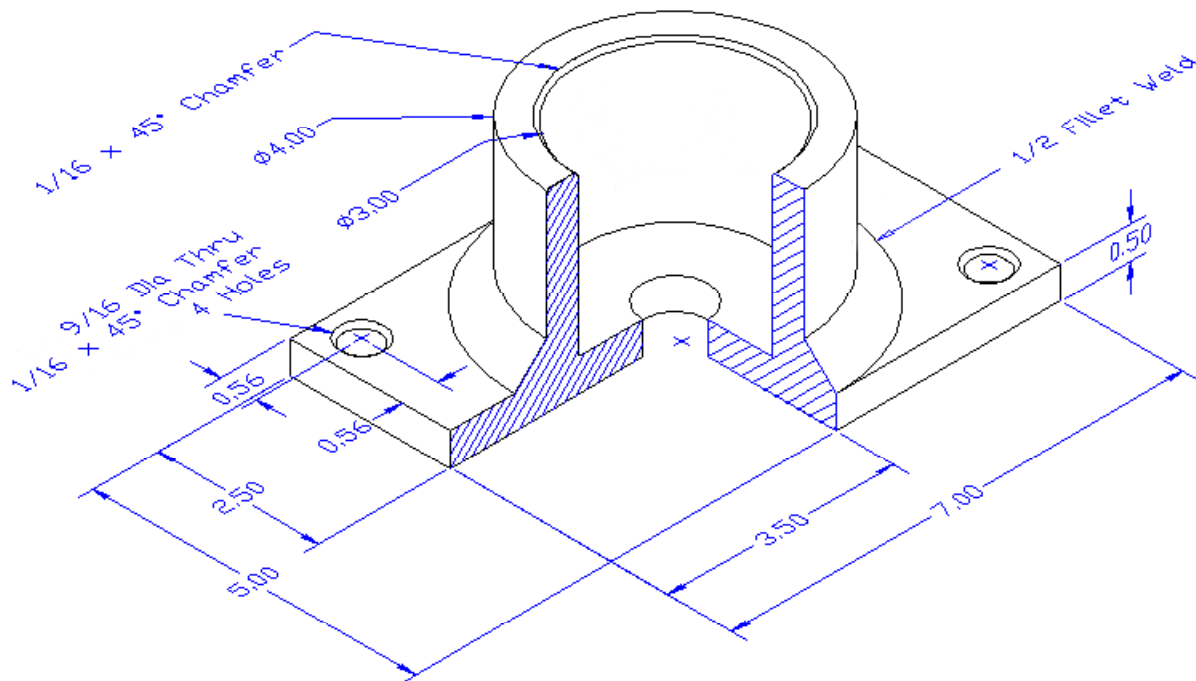

If you continue to use this solid to make the orthographic drawing in Paper Space, use the notes shown to the right.

Notes:

1. Material: Steel
2. Remove all sharp edges and burrs.
3. Cadmium plate
4. Tolerances unless otherwise specified:
2 decimal: ± 0.010
Angular: $\pm 0.1^\circ$

Figure A.1 – The Hub Plate

*** World Class CAD Challenge 03-A1* - Create a New file and draw the solid using the techniques in this chapter. Move the finished solid to the origin of the drawing. Complete the task in less than 5 minutes to maintain your World Class ranking.**

Send your best time and a copy of your drawing for verification to the authors of these problems to have your name, location and time posted. See the web site for instructions.

www.worldclasscad.com